



Smart Feeding Solutions for Bulk Material Processing

Coperion K-Tron Modular Feeders

Every Feeder Starts as a Volumetric Feeder

In principle, volumetric feeding is the simplest, most economical feeding solution available. Bulk material is held in a hopper and constantly fed into a process per unit of time. A gravimetric feed rate may be inferred through a calibration process where a timed

sample is taken and weighed, and screw speed adjusted accordingly. Although there is no weight feedback to assure feeding accuracy over time, this may not be a concern for materials with consistent bulk density.



Bulk Solids Pump Feeder

Choosing the Best Feeder for Your Process

Coperion K-Tron offers a wide variety of feeding solutions to handle most bulk materials in a wide range of applications involving prefeeding, feeding or batching.

Single Screw Feeders

handle free-flowing materials such as pellets and powders.

Twin Screw Feeders

handle more difficult materials such as pigments, sticky, bridging or flooding powders, fiber and fiberglass.

Vibratory Feeders

offer gentle feeding of free-flowing flakes, powders and other friable products.

Bulk Solids Pump Feeders

are designed for gentle and precise feeding of free flowing pellets, granules, flakes, powders and other friable products.

Weigh Belt Feeders

are perfect for gentle high rate feeding or metering of free flowing or friable products where low headroom is desirable.

Smart Flow Meters

are ideal for gentle high rate feeding or metering of free flowing or friable products.

Feed Rates to Meet a Wide Range of Applications

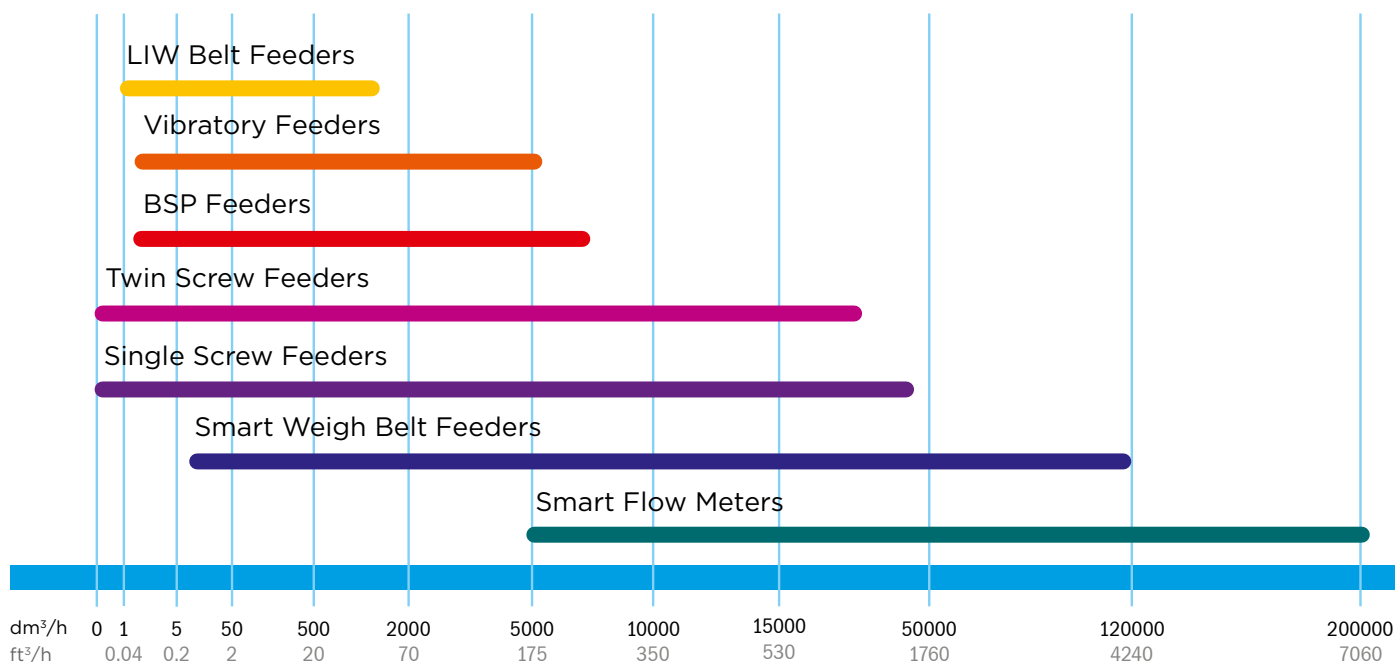

Feeding Principles

Volumetric Feeding Principle

The bulk material is discharged from a hopper with a constant volume per unit of time by regulating the speed of a feeding device. The actual volume of material fed is determined through calibration. The feeding accuracy is dependent on the uniformity of the material flow characteristics and the bulk density.

Application: Simple, economical solutions where a high degree of feed rate accuracy is not required.

Gravimetric Feeding Principle

The bulk material or liquid is discharged from a hopper by weighing the material being fed and regulating the speed of the feeding device. The weighing system with control compensates for non-uniform material flow characteristics and variations in bulk density, and therefore provides for a high degree of feeding accuracy.

Application: Monitored feeding. Material control. Set point input manually or by host computer or in master/slave operation.

Loss-in-weight Feeding Principle

A feeding device with a hopper containing the material to be fed is placed upon a platform scale or suspension scale weighing system. The weight of the feeding device and hopper is electronically tared. The bulk material or liquid is discharged from the hopper by the feeding device and the resultant weight loss per unit of time is determined by the weighing and control system. This actual weight loss per unit of time is compared to a desired weight loss per unit of time based upon a desired continuous feed rate setpoint. Any difference between the actual and desired weight loss per unit of time results in a correction to the speed of the feeding device.

When the hopper content reaches a predetermined minimum weight level, the control by weight loss is briefly interrupted and the hopper is refilled. During the refill period, weight is increasing and the controller regulates the speed of the feeding device based upon the historical weight and speed information that was determined during the previous weight loss cycle. The loss-in-weight feeder principle is most accurate when using a high resolution, fast responding, vibration immune weighing system combined with self tuning controls.



Modular Twin Screw Feeder

Core Feeding Technologies

Material Handling

No two process applications are the same, and Coperion K-Tron offers the widest range of material handling solutions in the industry. All volumetric feeders, loss-in-weight feeders, weigh belts, flow meters and conveying systems are offered in a variety of configurations, which can be combined to create an optimal solution for any application.

Precision Weighing

Coperion K-Tron's unique vibrating wire weighing technology is based on the theory that the resonance frequency of an oscillating wire depends on the wire tension produced when a load is applied. Force, when derived from an applied weight, is transferred mechanically to the wire. The resonant frequency is measured to determine the weight. In Coperion K-Tron's Smart Force Transducer (SFT), the signal is directly converted into a digital weight signal by a built-in microprocessor. The signal is then communicated noise-free via RS 485 to the controller. Every SFT provides a true 8,000,000:1 weight resolution in 20 ms and comes with a 5 year warranty.



Advanced Controls

No matter how simple or complex your feeder application may be, Coperion K-Tron has a control solution designed and priced to meet your needs.

Coperion K-Tron's SmartConnex™ concept represents a new control environment that tightly integrates the core technologies of a feeder system. This greatly reduces the cost of installation and daily operation, makes the system easier to use and maintain, and provides an optimum level of performance. In multi-feeder applications, SmartConnex can be used to form a network of feeders using simple field wiring techniques with superior performance.



Modular Product Lines for Flexible Solutions



TWIN AND SINGLE SCREW FEEDERS

Modular screw feeders offer numerous exchangeable components and various types of screws for feeding bulk solids.

Feed rates:
0.14 - 45,300 dm³/h
0.005 - 1,600 ft³/h



LOSS-IN-WEIGHT BELT FEEDERS

The use of a belt as the feeding device of a loss-in-weight system ensures gentle handling of difficult products with low melting points.

Feed rates:
1 - 1,200 dm³/h
0.04 - 40 ft³/h



VIBRATORY FEEDERS

Vibratory trays in three sizes can be combined with various hopper sizes to feed difficult materials like glass fiber.

Feed rates:
1 - 8,500 dm³/h
0.035 - 300 ft³/h



LIQUID FEEDERS

A wide range of pumps and tanks can be combined with a suspension scale or platform scale using SFT technology for gravimetric feeding of liquids.



BULK SOLIDS PUMP™ FEEDERS

The new BSP feeders provide gentle, precise feeding of free flowing materials. Four models can be combined with a suspension scale or platform scale to cover a wide range of feed rates.

Feed rates:
2 - 6,700 dm³/h
0.07 - 237 ft³/h



COMPACT FEEDERS

Available in single or twin screw configurations or with vibratory tray for feeding materials with high accuracy at low feed rates.

Feed rates:
0.03 - 313 dm³/h
0.0011 - 11 ft³/h



QUICK CHANGE FEEDERS

Twin and single screw feed modules can be interchanged to provide for quick cleaning and increased production flexibility.

Feed rates:
0.42 - 4,404 dm³/h
0.01 - 155 ft³/h



PHARMACEUTICAL FEEDERS

Designs include sanitary construction with two levels of surface finish and quick disassembly capability for easy cleaning. Drive motor and gearbox can also be enclosed in a sealed stainless steel housing.

Feed rates:
0.13 - 2,012 dm³/h
0.005 - 71 ft³/h



K4G GRAVIMETRIC BLENDER

Designed for the plastics compounding and extrusion market, systems can be arranged in compact groups of up to six feeders.

Feed rates:
0.5 - 2,388 dm³/h
0.02 - 84 ft³/h



FEED RATES

The feed rate range is determined by the equipment configuration and the selected scale capacity. Each feeder type is available in modular configurations that provide for an overlap of feed rate capacities. The stated feed rates are for the smallest equipment configuration to the largest equipment configuration within that type. Typical feed rate turndown capacity within any single configuration is 20:1.



MID-RATE BELT FEEDERS

Two sizes of mid-rate Smart Weigh Belt feeders are available, with and without housing, for medium rate gravimetric feeding or metering. A continuous online auto-tare option reduces downtime for calibration and maintenance.

Feed rates SWB-300/600:
10 - 80,000 dm³/h
0.4 - 2,800 ft³/h

HI-RATE BELT FEEDERS

Three sizes of hi-rate Smart Weigh Belt feeders are available, with closed or open housing, for high rate gravimetric feeding or metering.

Feed rates SWB-650/800/1000:
2,000 - 120,000 dm³/h
70 - 4,200 ft³/h

Coperion K-Tron Smart Flow Meters

For reliable feeding, metering or monitoring of solid bulk material flows the Coperion K-Tron Smart Flow Meter (K-SFM) is an ideal alternative to traditional feeder configurations.

The K-SFM has no moving parts, thereby ensuring gentle handling of the bulk material - a distinct advantage over other flow meter technologies. The simple, yet robust, design allows the K-SFM to provide an accurate measurement in most conditions. The bulk material flows through two measuring channels, which use highly accurate, patented Smart Force Transducer technology to determine the actual flow rate.

The K-SFM can be used for any free flowing bulk material with particle sizes from 0.2 mm up to 10 mm, such as powders, grains, pellets, chips, fibers and many more.

The K-SFM has been successfully implemented in a wide range of applications in diverse industries such as plastics, chemicals, food, animal feed, cement, coal, glass, aluminum, grain, etc.

Application examples: material flow control within a production line, measuring filling or discharge quantities, materials management and quantitative bulk goods measurement.

Features:

- › Feed rates of 2 - 300 tons/hr
- › Highly accurate
- › Practically maintenance free
- › Automatic taring before the measuring process
- › Automatic taring during the measuring process
- › Free passage for the bulk material
- › No moving parts
- › Gentle handling of the bulk material
- › Reliable
- › Simple design, quick disassembly
- › Function not affected by bulk material characteristics
- › State-of-the-art weighing technology



Anatomy of a Modular Loss-in-Weight Feeder

Features and Benefits

The Coperion K-Tron Control Module (KCM-III) combines the feeder control function together with the motor drive or vibratory tray drive and mounts directly on the feeder frame in an IP65 / Nema 4 enclosure. This eliminates the need to mount these components in remote control panels and eliminates expensive cabling between the feeder and the operator interface in the control room. All wiring between the weighing system, motor and KCM is done at the factory thus reducing installation time and expense. Connecting all feeders in a process line to the operator interface in the control room is accomplished using a single cable with standard serial communications protocol. For hazardous or hostile environments, the KCM can be remote mounted and replaced with a connection box.

Hoppers are available in a variety of configurations. Symmetrical and asymmetrical hoppers with and without vertical agitation are available depending on the flow characteristics of the material to be fed.

The feeding module is supported on a swing out structure that allows for quick cleaning or changing to a variety of units. Screw feeding units with horizontal agitators as well as vibratory trays, belts, Bulk Solids Pumps and other feeding devices can be supplied.

CONTROL MODULE OR JUNCTION BOX

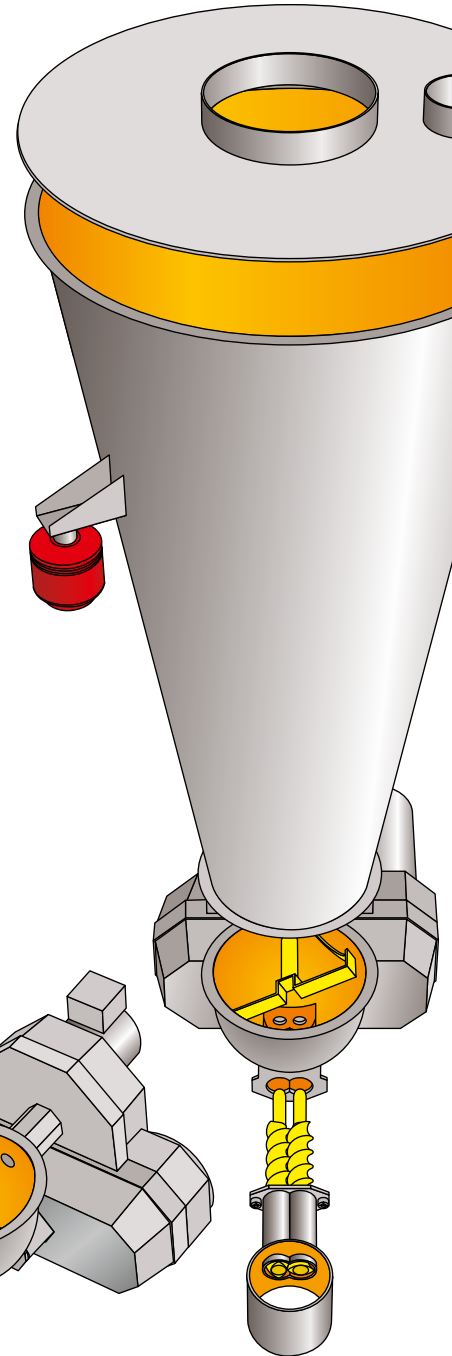

HOPPERS

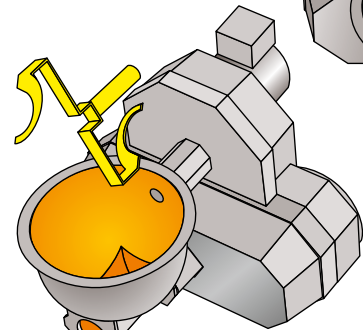

MODULAR FEEDING DEVICES

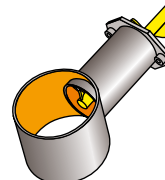

INLET/REFILL Hopper lids can accommodate manual or automatic refills, depending on feed rates. When automatic, the inlet and vent size is determined based upon refill rate, material flow characteristics and hopper size. Connection to the upstream refill device is made via a flexible bellows. Pressure compensation systems are available upon request.

AIR/VENTILATION During the feeding process, air must enter and leave the hopper as the process material is being discharged or refilled. The vent connection is provided for this purpose and can be connected to: plant-wide dust collection systems, the refill container, the atmosphere through an attached fabric filter, the atmosphere through a self-cleaning jet filter mounted on the hopper. Connection to upstream hoppers or central collection systems is made with a flexible bellows.

SMART FORCE TRANSDUCER WEIGHING TECHNOLOGY High resolution (8 parts / million), zero deflection, vibration and temperature immune weighing system provides for the fastest most accurate weight information to be available to the control system. Available as a platform scale or three-point suspension scale system as shown here.

GEAR BOX/MOTOR DRIVES A variety of gear box types and sizes is available to accommodate a broad range of feed rate ranges. Motors are available as DC drives with 100:1 turndown capability, AC drives with 20:1 turndown capability and stepper drives. A variety of drives are available to meet hazardous location requirements.

DISCHARGE Discharge configurations can be supplied as open horizontal, closed vertical, and closed vertical with pressure compensation designs. Separate sampling valves are available to divert materials for calibration checks.

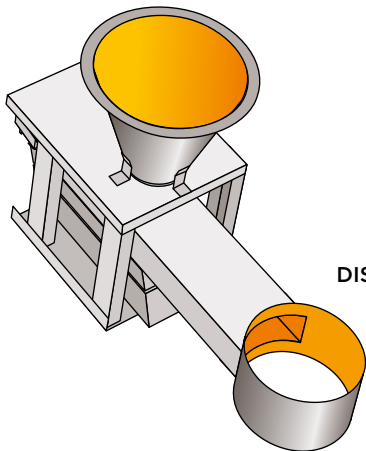

The Right Feed Screw for Every Application

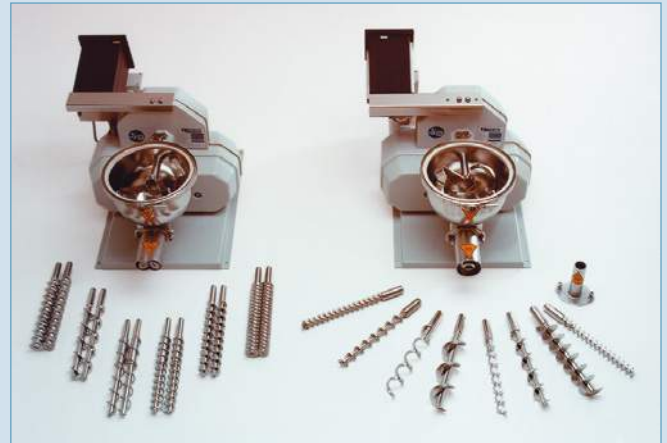

Screw feeding units use Coperion K-Tron's unique Powersphere design with horizontal agitation to provide the most uniform fill of material into the discharge screw thus improving feeding accuracy over a greater turndown range. Single and twin screw configurations are available with a variety of screw designs to accommodate the broad range of materials that have to be fed.

Years of experience feeding all kinds of materials can be accessed in our test lab databases. Fully equipped testing facilities around the world can help in making the optimal equipment selection.

Twin Feed Screws

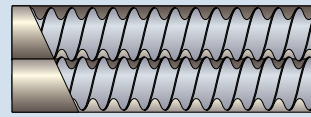

Twin concave-profile screws for free-flowing and sticky powders

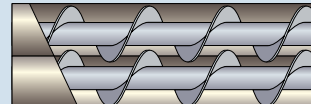

Twin auger screws for pellets or pellet-powder mixtures

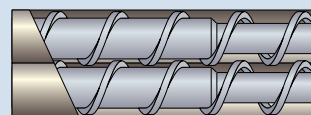

Twin spiral screws for difficult pellet-powder mixtures

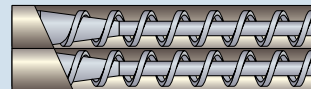

Double spiral screws for pellets

Single Feed Screws

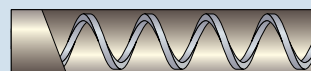

Single spiral screws for pellets

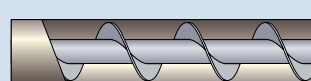

Single auger screws for poorly flowing powders

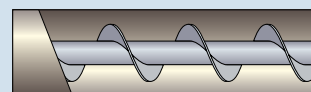

Single auger screws with wider tube for large pellets

Smart Solutions for Material Handling

Since its creation in 1964, Coperion K-Tron has defined the leading edge of technology for material handling applications in the process industries. Coperion K-Tron designs, produces, sells and supports feeding and conveying equipment as well as complete process solutions.

Coperion K-Tron Test Labs

Fully equipped testing facilities help in making the optimal equipment selection.

Systems Engineering Support

One source engineering of your entire material handling project. Our system engineer will work with you from concept to commissioning.

Worldwide Service Support

Trained, certified service engineers located around the world to provide twenty-four hour technical support and solve your problem any time, any day.

Custom Service Programs

Start-up and preventive maintenance programs designed for your specific installation.

Spare Parts

Quick delivery so you can safely limit your inventory to the most critical parts.

Professional Training

The Coperion K-Tron Institute provides hands-on maintenance, mechanical and operator training for all of your Coperion K-Tron equipment, either on-site or at a Coperion K-Tron facility.

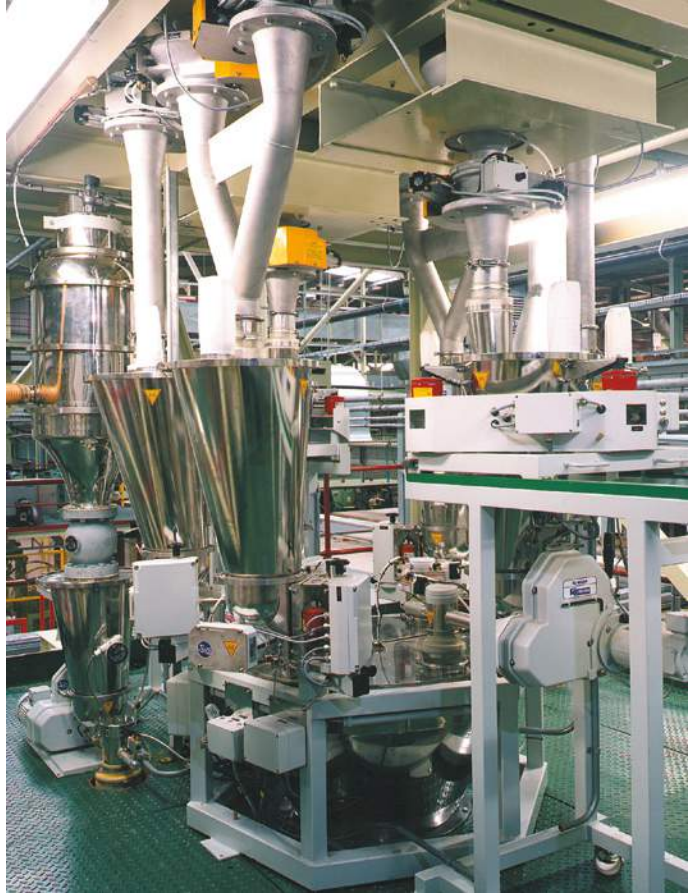

Modular volumetric and loss-in-weight feeders integrated with a gravimetric blending system and pneumatic receivers in a plastics extrusion process

www.coperion.com

›Manufacturing, Sales and Engineering:

Coperion K-Tron Salina, Inc.

606 North Front St.
Salina, KS 67401 USA
Tel +1 785 825 1611
Fax +1 785 825 8759

Coperion K-Tron (Switzerland) LLC

Lenzhardweg 43/45
CH-5702 Niederlenz
Tel +41 62 885 71 71
Fax +41 62 885 71 80

›Sales and Engineering:

Americas

Coperion K-Tron Salina, Inc.
Sewell Office
590 Woodbury-Glassboro Rd
Sewell, NJ 08080 USA
Tel +1 856 589 0500
Fax +1 856 589 8113

Asia Pacific

Coperion K-Tron Asia Pte Ltd
8 Jurong Town Hall Road
#28-01/02/03 The JTC Summit
Singapore 609434
Tel +65 6418 8200
Fax +65 6418 8203

British Isles

Coperion K-Tron Great Britain Ltd.
4 Acorn Business Park
Heaton Lane
Stockport SK4 1AS
United Kingdom
Tel +44 161 209 4810
Fax +44 161 474 0292

China

Coperion K-Tron (Shanghai) Co. Ltd.
Building A2-A3
No. 6000 Shen Zhuan Gong Road
Songjiang district
CN-201619 Shanghai
Tel +86 21 6767 9505
Fax +86 21 6767 9108

France

Coperion S.à.r.l.
56, boulevard de Courcerin
FR-77183 Croissy-Beaubourg
Tel +33 1 64 80 16 00
Fax +33 1 64 80 15 99

Germany

Coperion K-Tron Deutschland GmbH
Heinrich-Krumm-Strasse 6
DE-63073 Offenbach (Main)
Tel +49 69 8300 8990
Fax +49 69 8300 9498

info@coperion.com

coperion
K-TRON